

Bemerkungen  
NOTES

- 1 Kammer geeignet für TE Connectivity Timer-Kontakte: PN 926965  
CAVITY SUITABLE TO TE Connectivity TIMER-CONTACTS: PN 926973  
PN 926005  
PN 926006  
PN 927833  
PN 927837
- 2 Rasthaken zwischen Kammer Nr. ... (siehe Blatt 2 von 2)  
LOCKING LATCH BETWEEN CAVITY NO. ... (SEE SHEET 2 OF 2)
- 3 Kodierrippe zwischen Kammer Nr. ... (siehe Blatt 2 von 2)  
KEYING RIB BETWEEN CAVITY NO. ... (SEE SHEET 2 OF 2)
- 4 Polarisierungsrippen durchgehend bis Scharnier, nach unten (Lage "a")  
oder oben (Lage "b") versetzt, bei Kammer Nr. ... (siehe Blatt 2 von 2)  
POLARIZATION RIB GO THROUGH TO HINGE, POSITION "a" OR  
"b", AT CAVITY NO. ... (SEE SHEET 2 OF 2)
- 5 Verrastung für Deckel bei Kammer Nr. ... (siehe Blatt 2 von 2)  
LOCKING DEVICE FOR COVER AT CAVITY NO. ... (SEE SHEET 2 OF 2)
- 6 Firmenlogo und Teile-Nr.  
ARTWORK-LOGO AND PART #
- 7 Kammernummer  
CAVITY NUMBER
- 8 Tiefenanschlag zwischen Kammer Nr. 1 und 2, ebenfalls  
zwischen der letzten und vorletzten Kammer  
MATING STOP BETWEEN CAVITY NO. 1 AND 2, ALSO  
BETWEEN THE LAST AND THE LAST BUT ONE CAVITY
- 9 Maß A und Maß B siehe Blatt 2 von 2  
DIMENSION A AND DIMENSION B SEE SHEET 2 OF 2
- 10 Passender TE Connectivity Gegenstecker: (siehe Stückliste)  
MATED WITH TE Connectivity CONNECTOR: (SEE PARTS LIST)
- 11 Generell passende Flachsteckerwanne siehe Geräteanschlußzeichnung 88-9935-3  
GENERAL SUITABLE TAB HEADER HOUSING SEE DRAWING 88-9935-3
- 12 Leiterplattenanschluß siehe Zeichnung 88-9935-1  
CONNECTION TO THE PC BOARD SEE DRAWING 88-9935-1
- 13 SPECIAL HOUSING: MATERIAL MEET REQUIREMENTS OF UL94 V0 AND GWT 750 NO FLAME (IEC 60695-2-11)
- 14 PRELIMINARY PART: NOT YET RELEASED FOR PRODUCTION
- 15 MATERIAL: PA66 UL94 V0 AND GWT 750 NO FLAME (IEC 60695-2-11)

Deckel geschlossen gezeichnet  
COVER DRAWN CLOSED

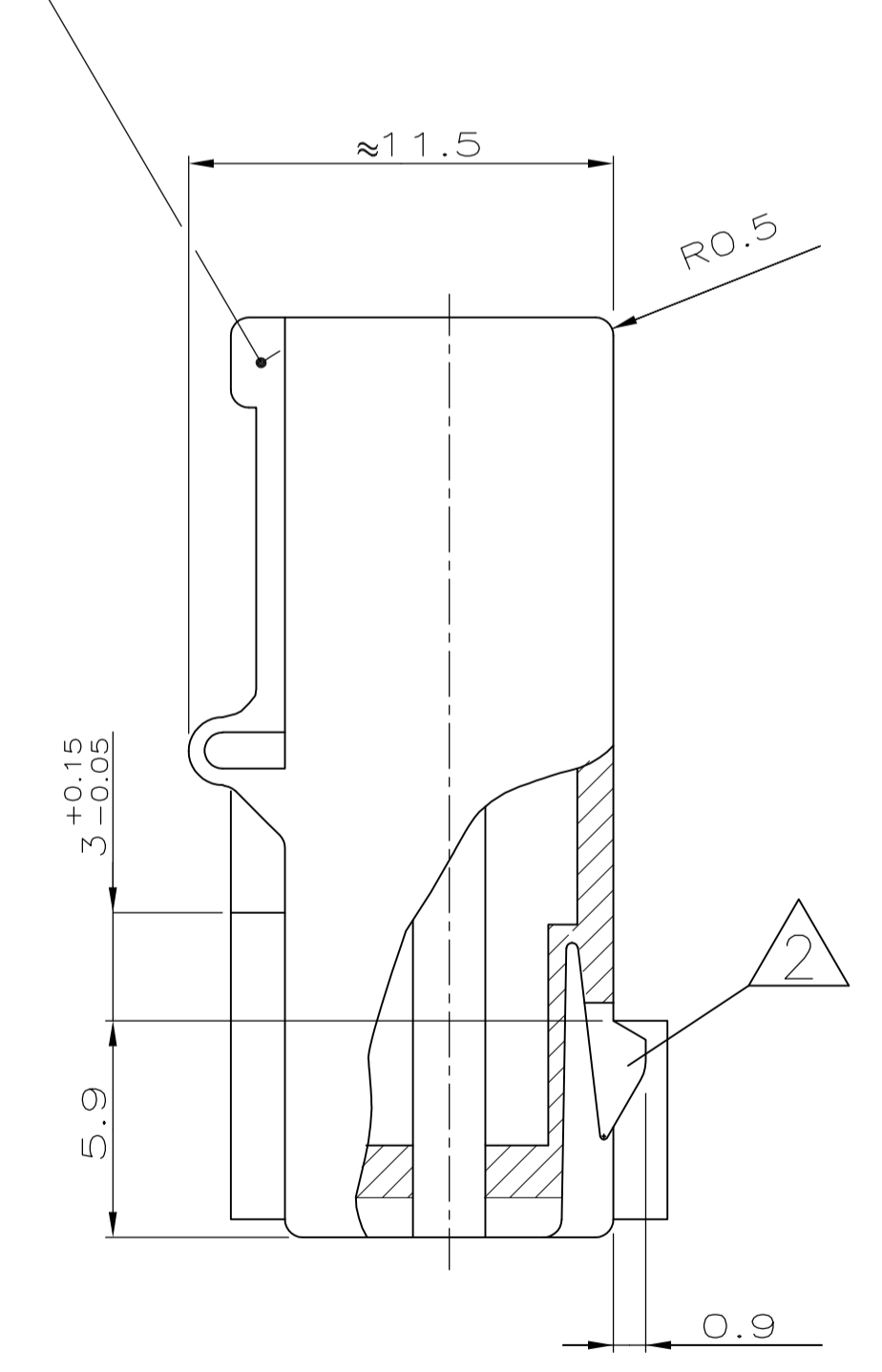

Ansicht "Z"  
VIEW "Z"



Tabelle mit Ausführungsvarianten  
und Bestellnummern auf Blatt 2 von 2  
LIST WITH DIFFERENT STYLINGS AND  
PARTNUMBERS SEE SHEET 2 OF 2

siehe Blatt 2 / SEE SHEET 2				
BESTELL-NR.	POS.	STÜCK	BENENNUNG EINZELTEIL	WERKSTOFF
				OBERFLÄCHE FARBE

THIS DRAWING IS A CONTROLLED DOCUMENT. DIESE ZEICHNUNG IST EIN KONTROLLIERTES DOKUMENT.		DIN G.Holgus 20.02.89
DIMENSIONS: MASSEINHEITEN: mm		CIK B.Schnaubelt 20.02.89
TOLERANCES UNLESS OTHERWISE SPECIFIED: ALLE REIN-TOLERANZEN		APVD
0. PLC ± -	1. PLC ± 0.2mm	PRODUCT SPEC PRODUKTSPEZ
2. PLC ± -	3. PLC ± -	APPLICATION SPEC VERARBEITUNGSSPEZ
4. PLC ± -	ANGLES / WINKEL ± 1°	WEIGHT GEWICHT
FINISH / OBERFLÄCHE / FARBE		SCALE MASSSTAB

ZEICHNUNG GÜLTIG AB .....			
<b>STE</b> TE Connectivity			
NAME			
2-12 pol. Standard-Timer Gehäuse mit Innenverrastung, Raster 5mm 2-12 POS. STANDARD-TIMER HOUSING WITH INTERIOR LOCKING, PITCH 5mm			
SIZE	CAGE CODE	DRAWING NO. ZEICHNUNGS-NR.	RESTRICTED TO KUPFER
A1	00779	928343	
CUSTOMER DRAWING / KUNDENZEICHNUNG		SCALE MASSSTAB	SHEET BLATT
		5:1	1 OF 2 REV

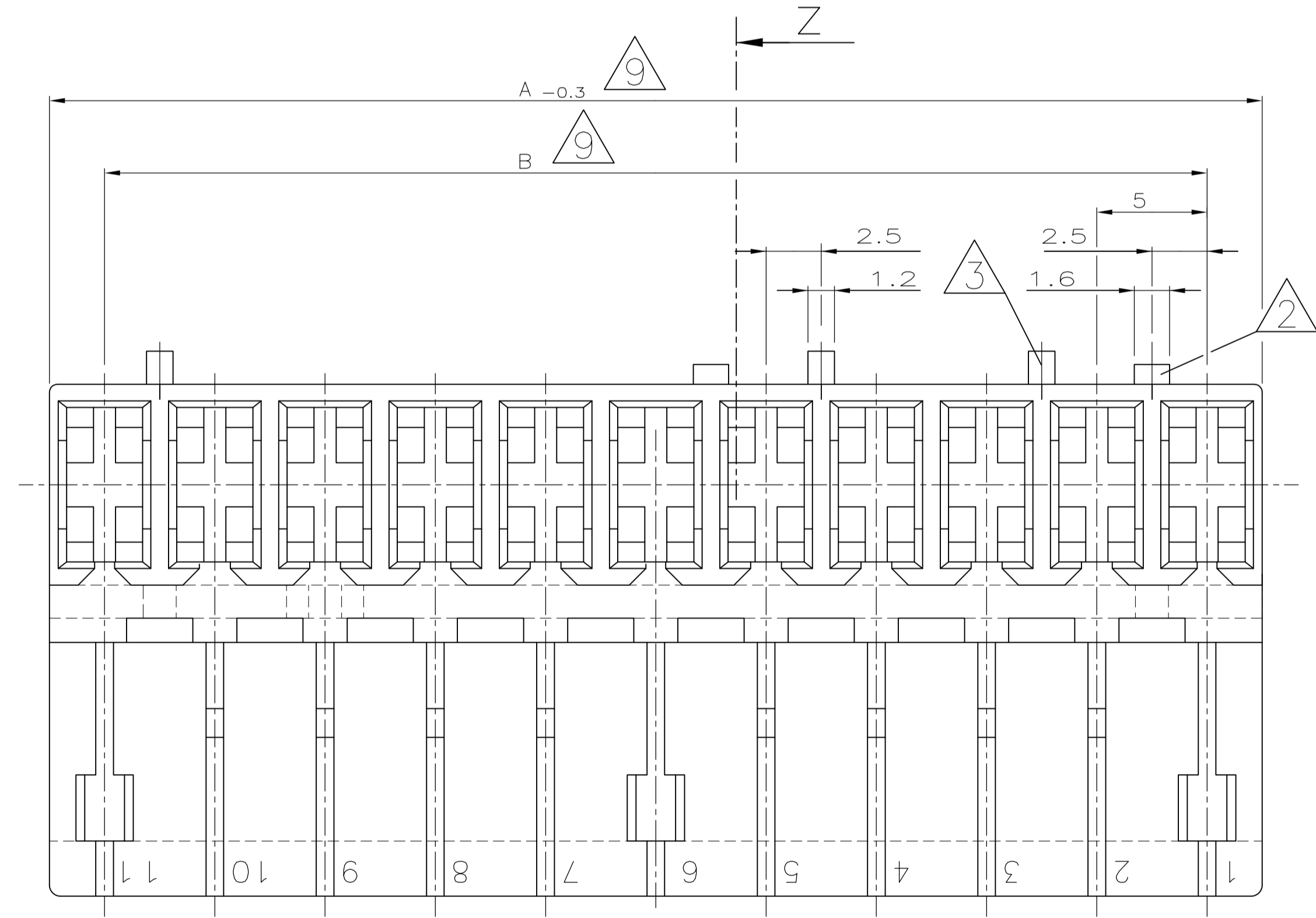
~ 927740

THIS DRAWING IS UNPUBLISHED.  
VERTRAULICHE UNVERÖFFENTLICHTE ZEICHNUNG

RELEASED FOR PUBLICATION  
FREI FUER VEROEFFENTLICHUNG  
ALL RIGHTS RESERVED.  
ALLE RECHTE VORBEHALTEN

VERWENDET FÜR

WAR NR.

CAD-ORIGINAL  
ZEICHNUNG NICHT ÄNDERN

ÄNDERUNGEN DIE DEM TECH-  
NISCHEN FORTSCHRITT DIENEN,  
BEHALTEN WIR UNS VOR

LOC DIST

REVISIONS  
ÄNDERUNGEN

DESCRIPTION  
BESCHREIBUNG

DATE DWN APVD

P	LTR	DATE	DWN	APVD
-	-	SEE SHEET 1	-	-

2pol.

3pol.

4pol.

5pol.

6pol.

7pol.

8pol.

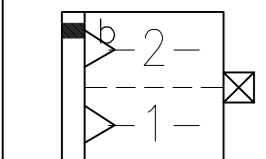

0-928343-2  
1-928343-2

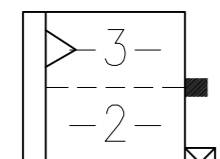

0-928 343-3  
0-1703059-3

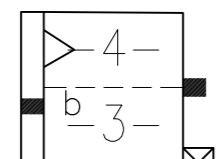

0-928343-4

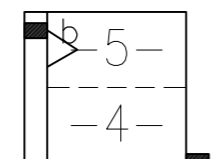

0-928343-5  
3-928343-5

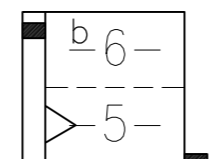

0-928343-6

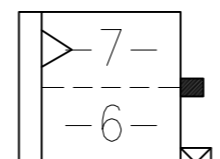

0-928343-7

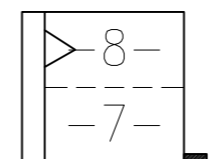

0-928343-8

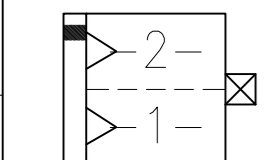

0-2178561-2

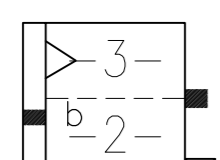

2-928 343-3

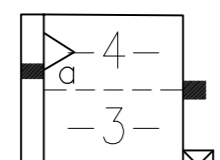

2-928343-4

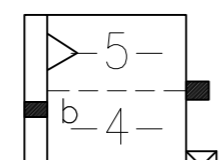

2-928343-5

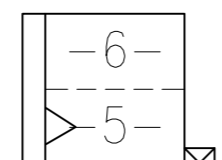

2-928343-6

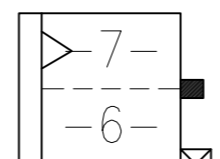

2-928343-7

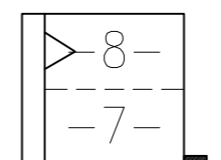

2-928343-8

9pol.

11pol.

12pol.

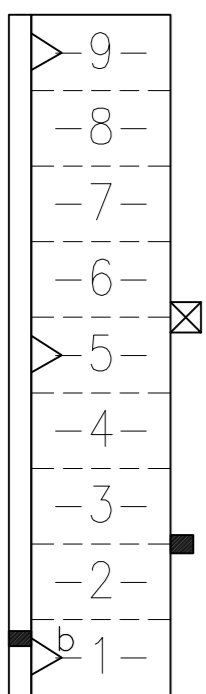

0-928343-9

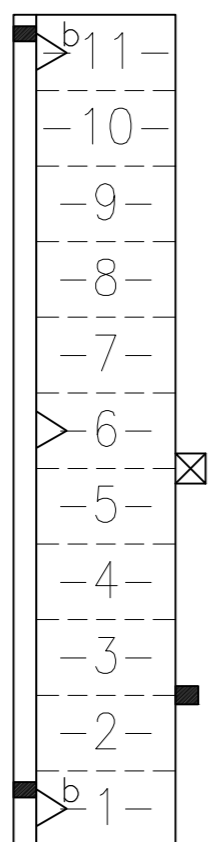

1-928343-1

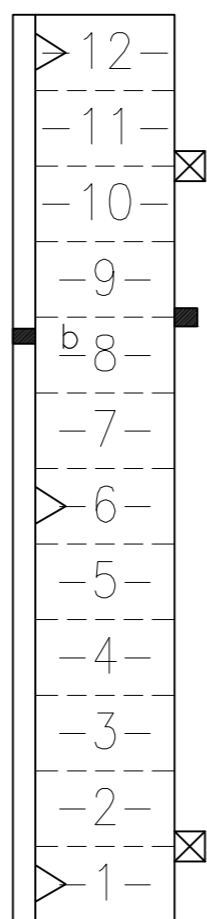

1-928343-2

~927740

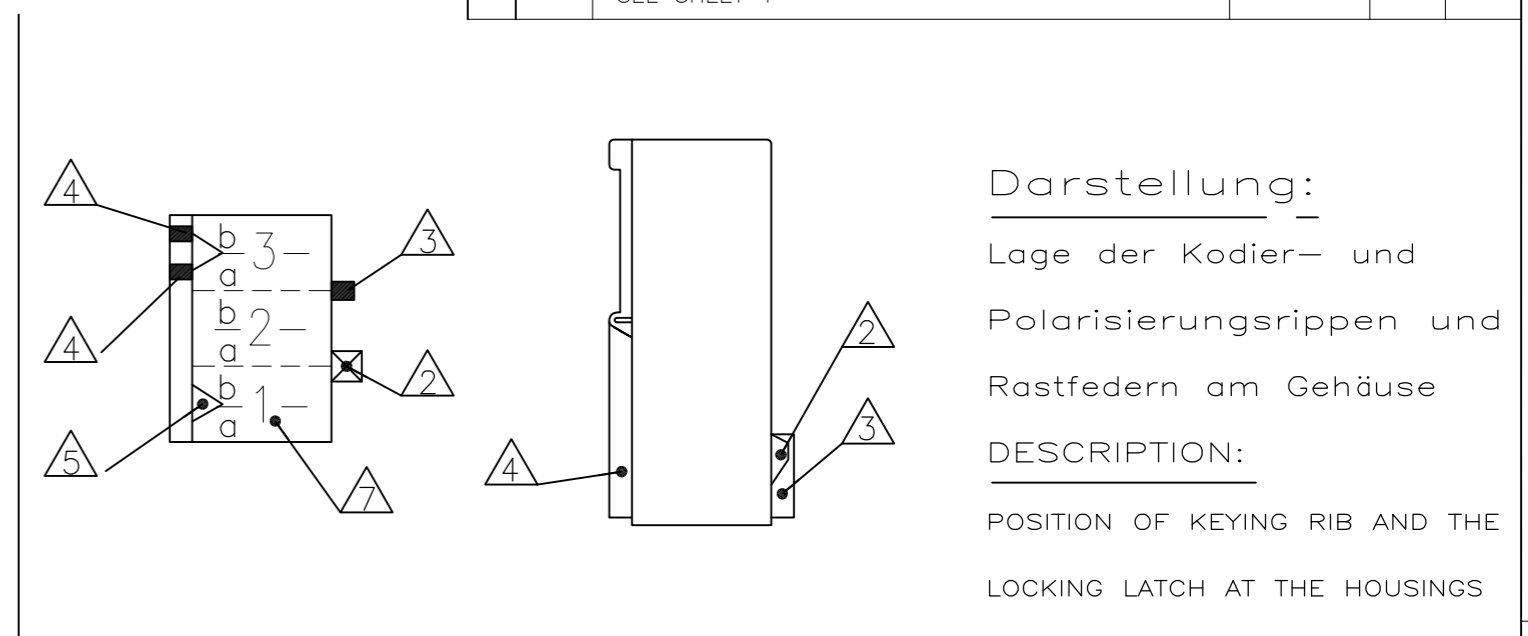

Darstellung:

Lage der Kodier- und  
Polarisierungsrippen und  
Rastfedern am Gehäuse

DESCRIPTION:

POSITION OF KEYING RIB AND THE  
LOCKING LATCH AT THE HOUSINGS

3-928343-5	5	25	20	natur	PA6.6	1	0-927742-5	11 12
1-928343-2	2	10	5	natur	PA6.6	1		11 12
0-2178561-2	2	10	5	natur	PA6.6	1		-
0-1703059-3	3	15	10	natur	PA6.6 V-0	A	0-927742-3	
1-928343-2	12	60	55	natur		B		
1-928343-1	11	55	50	natur		B		
0-928343-9	9	45	40	natur		B		
3-928343-8	8	40	35	grau		B		
2-928343-8	8	40	35	schwarz		B	0-928230-8	
0-928343-8	8	40	35	natur		B	0-928309-8	
2-928343-7	7	35	30	schwarz		B		
0-928343-7	7	35	30	natur		B	0-928309-7 0-927742-7	
2-928343-6	6	30	25	schwarz		B		
0-928343-6	6	30	25	natur		B	0-927742-6	
2-928343-5	5	25	20	schwarz		B		
0-928343-5	5	25	20	natur		B	0-927742-5	
2-928343-4	4	20	15	schwarz		B		
0-928343-4	4	20	15	natur		B	0-927742-4	
3-928343-3	3	15	10	grau		B		
2-928343-3	3	15	10	schwarz		B		
0-928343-3	3	15	10	natur		B	0-927742-3	
0-928343-2	2	10	5	natur		B		
Bestell-Nr.	Pol-zahl	Maß A	Maß B	Farbe	Material	Rev.	Gegenstecker	
PART NO.	POS.	DIM A	DIM B	COLOUR	MATERIAL	REV.	MATED WITH	

ZEICHNUNG GÜLTIG AB

THIS DRAWING IS A CONTROLLED DOCUMENT. DIESE ZEICHNUNG IST EIN KONTROLLIERTES DOKUMENT.		DWN G.Holaus 20.02.89	 TE Connectivity
DIMENSIONS: MASSEHEITEN mm		CHK B.Schnaubelt 20.02.89	
TOLERANCES UNLESS OTHERWISE SPECIFIED: ALLGEMEINTOLERANZEN		APVD -	NAME
0 PLC ± - 1 PLC ± 0.2 2 PLC ± - 3 PLC ± - 4 PLC ± - ANGLES / WINKEL ± 1°		PRODUCT SPEC PRODUKTSPEZ. -	2-12 pol. Standard-Timer Gehäuse mit Innenverrastung, Raster 5mm 2-12 POS. STANDARD-TIMER HOUSING WITH INTERIOR LOCKING, PITCH 5mm
MATERIAL		APPLICATION SPEC. VERARBEITUNGSSPEZ. -	SIZE A2
FINISH / OBERFLÄCHE / FARBE		WEIGHT GEWICHT -	CAGE CODE 00779
		SCALE MASSSTAB 2:1	DRAWING NO. ZEICHNUNGS-NR. C=928343
		CUSTOMER DRAWING / KUNDENZEICHNUNG	RESTRICTED TO NUR FUER -
		SHEET BLATT 2 OF VON 2	REV B6

Bemerkungen siehe Blatt 1 von 2  
NOTES SEE SHEET 1 OF 2